



“MUSA Plus”

Electronic control for towel radiators

MUSA Plus is a digital chronothermostat for the automatic control of electric towel radiators.

By means of an external sensor is capable of keeping the room temperature at a desired value. MUSA Plus has a simple yet modern design, suitable for every

type of furnishing and every model

of electric towel radiator.

MUSA Plus is easy to install and

it is available in several colors.

MUSA Plus is a certified product.



Available colours: -White
-chrome



MUSA Plus is compliant with the following standards:

-Eco-design Directive for Energy-using Products, 2005/32/EC (<0,5W).

-EN 60335-1:2012+A11:2014

-EN 60335-2-43:2003+A1:2006+A2:2008

-EN 61000-3-2:2014 -EN61000-3-3:2013 -EN 62233:2008

-EN 55014-1:2006+A1:2009+A2:2011

-EN 55014-2:1997+A1:2001+A2:2008



“MUSA Plus”

Electronic control for towel radiators

Introduction

- Seven operational modes: Comfort, Night, Antifreeze, Fil-Pilote, Chrono, Timer-2h, Stand-by.
- "Comfort" mode: The thermostat keeps the room temperature at the value set by the user.
- "Night" mode: The electronic control keeps the room temperature to a level below the configured "Comfort" value.
- "Antifreeze" mode: The electronic control keeps the room temperature above 7°C.
- "Fil-Pilote" mode: The operations of device are controlled through the signal received from the "Fil-Pilote" system.
- "Timer-2h" mode: The electronic control powers the heating element for a period of 2 hours independently of the configured temperature. At the end of the 2 hours time period, the device returns to previous operational mode. For safety reasons, during the 2 hours time period the room temperature is automatically controlled in order not to exceed 32°C.
- "Chrono" mode: The electronic control operates according to a daily/weekly program. The program is user defined.
- In "Stand-by": The electric resistance is not powered and all lights are turned off, however the device is still operative.

Further features:

- Large backlit display showing the configured temperature, time, program and current operational mode.
- The operational mode and all related functions can also be set through the IR remote control (optional).
- The user according to his needs can configure the daily/weekly program.
- The “**Open Window Detection**” function enables detecting of an open window by sensing a sudden decrease of the temperature in the room. In such a case, the device deactivates the heating element for a maximum of 30 minutes or until an increase of the room temperature reveals that the window has been closed.



“MUSA Plus”

Electronic control for towel radiators

Technical Specifications

Product	Digital electronic control for towel radiators
Application	Towel radiators
Version	Class I Class II
IP Level	IP44
Fil-Pilote	Only available for Class II
Room temperature setting	Digital through buttons
Display	Temperature, date/time, mode/functions, indication of heating activity, key lock, white backlighting
Funtion	Comfort, Night, Antifreeze, Stand-by, Fil-Pilote, Timer-2h, Chrono-thermostat, Open Window Detection.
Selectable temperature range	7°C ÷ 32°C
Operational temperature	-10°C ÷ +40°C
Maximal power	2000W
Supply voltage	230VAC 50Hz
Size	113 x 73 x 40mm (H x Lx I)
Connection to the heating element	Faston 6.3x0.8mm Phase, neutral, tEarth (Class I)
Temperature sensor	10KOhm at 25°C, type NTC
Warranty	2 years
Standard	-EN 60335-1:2012+A11:2014 -EN 60335-2-43:2003+A1:2006+A2:2008 -EN 61000-3-2:2014 -EN61000-3-3:2013 -EN 62233:2008 -EN 55014-1:2006+A1:2009+A2:2011 -EN 55014-2:1997+A1:2001+A2:2008
Approval mark	CE
Environmental directive	WEEE, RoHS

Notes

Repairs: Any servicing or repair work must be carried out by an authorized service center.

Compatibility with other products: Contact your distributor.

Warranty: 2 years from the date of purchase. This guarantee does not cover and is void with respect to the following:

- Products which have been subjected to unauthorized repair or improper maintenance by the user;
- Products which have been subjected to improper installation or any misuse contrary to the instructions in this user manual;
- Products which have been subjected to unauthorized modifications or other acts by the user.



“MUSA Plus”

Electronic control for towel radiators

WARNING RISK OF ELECTRIC SHOCK!
Disconnect power supply before proceeding with installation.

Preserve with care the present instruction sheet and read carefully before using the device.

- The present device has been designed for exclusive use on a towel radiator.
- The thermostat is designed for heating the liquid contained inside a towel radiator in combination with a heating element. Any other use is forbidden.
- Before using, carefully ensure that the line voltage is the same as that specified for the device (see technical specifications).
- Only use heating elements compatible with the type of used towel radiator.
- Disconnect power supply before cleaning or performing maintenance of the product.
- In case of damage of the power supply cable shut down the device and do not tamper with it. The damaged power supply cables can be replaced exclusively by the manufacturer or by an authorized service center. Failure to comply with the above rules could lead to compromised system safety and void the warranty.
- Store and transport the heating element exclusively in the protecting packaging.
- Replacement of the heating element can be done exclusively by the product manufacturer.
- Children aged under 8 years old and people with reduced physical, sensory or mental abilities.
- can use the device only under supervision. Children should not play with the device.
- Cleaning and maintenance meant to be carried out by the user should not be done by children without supervision.

CONNECTIONS TO ELECTRIC MAINS

The available versions are the following:

- 1 Schuko plug, UK plug, Swiss plug, Italian plug (Class I or Class II) for direct connection.
- 3-wires for Class I models: Live (brown); Neutral (blue); Earth (green-yellow).
- 2-wires for Class II models: Live (brown), Neutral (blue).
- 3-wires for Class II models with "Fil-Pilote": Live (brown), Neutral (grey), "Fil-Pilote" (black).

Rev. 04 - October 2015



“MUSA Plus”

Electronic control for towel radiators

Installation guide

For use by installer only



WARNING:

Disconnect the power supply before proceeding with installation. The installation has to be performed only by authorized personnel.

- The electronic control must be connected to the electric resistance only by authorized personnel.
- Make sure that the power of the electric resistance does not exceed the maximum power of the towel radiator

Example of heating element (Class II).

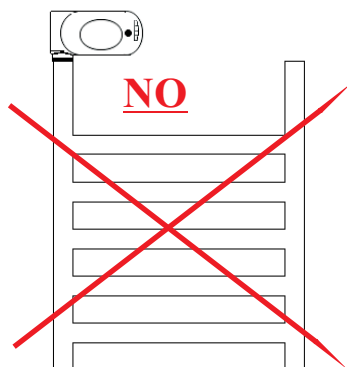
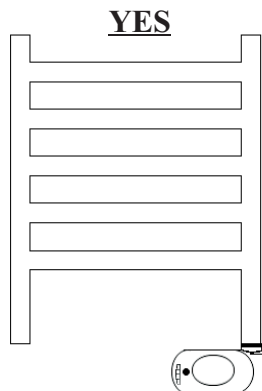
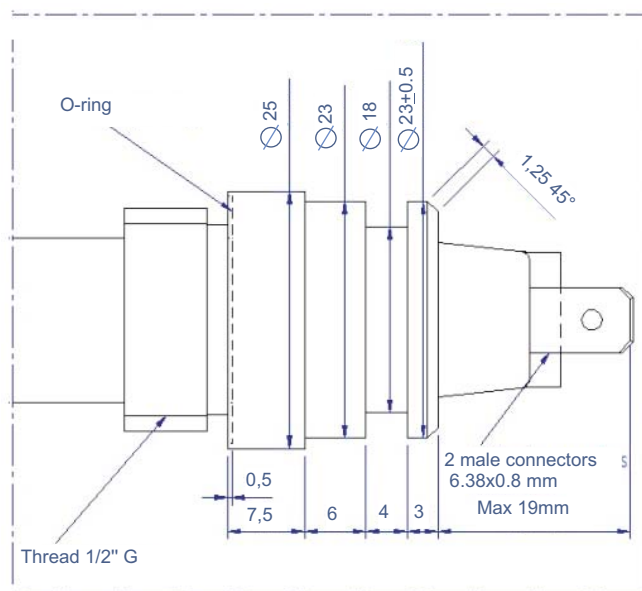
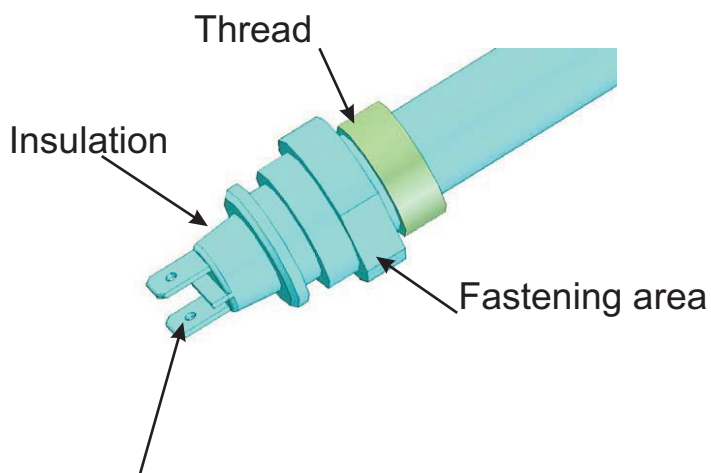

IMPORTANT: Pay attention to the maximal length of the 19mm connector (see picture above). Longer connectors could damage the device.



“MUSA Plus”

Electronic control for towel radiators

- **Disconnect power supply before installation.**
- **Only qualified personnel can connect the electronic device to the heating element.**
- **Make sure that the power of the electric resistance does not exceed the maximum power allowed by the electronic control device.**

1. Make sure that the towel radiator does not have leakage or air lock.
2. The device shall not be positioned directly in front of an electric plug.
3. Prevent water jets from hitting the equipment.
4. Connect the temperature controller only to a suitable heating element.
5. Ensure that the mains voltage is the same as indicated in the technical specifications.
6. Make sure that the type of electric resistance is compatible with the model of towel radiator being used (check the product specifications provided by the manufacturer). The usage of a heating element with higher power:
 - Does not increase the actual power of the towel radiator;
 - Might shorten life of the heating element;
 - Could damage the equipment.
7. Make sure that the power of the electric resistance does not exceed the maximum power of the towel radiator (check the label on the heating element).
8. When installed in a room with bathtub or shower, respect the “Protection Zones” according to IP44 insulation class (in UK according to IEE cabling directives). Furthermore, make sure to respect all local safety directives.
9. The device has to be protected by a 30mA circuit breaker (RCD).
10. Power the device with the recommended voltage (see technical specifications).
11. For models having no plug it is necessary to install a suitable omnipolar disconnection switch ensuring complete disconnection in case of category III overvoltage (that means a switch with at least 3 mm of space between open contacts).
12. After ensuring that the "O-Ring" is correctly positioned, screw the electric resistance in the relevant threaded hole of the towel radiator, properly secure it and insert the cover ring.
13. Place the "O-Ring" before the fastening area.
14. Extract the connecting cables from the device. The four poles connector and the ground connector (only Class I).
15. Connect the four poles connector to the heating element.
16. Connect the female Faston connector to Earth (only Class I).
17. Insert the lower part of the heating element into the ready connected thermostat.
18. Align the device to the towel radiator. Warning! Do not rotate the device more than 30 degrees on both directions.
19. Push the device against the base of the heating element to compress the “O-Ring”, properly fix the related fastener so that the device remains well secured and does not rotate around the heating element.
20. Connect the power supply cable.

DISPOSAL

This product may not be treated as ordinary household waste. It has to be disposed in proper waste collection sites. In case of replacement it shall be returned to the distributor. Such an end-of-life treatment of the product will preserve the environment and will reduce consumption of natural resources. This symbol applied to the present product indicates the obligation to bring it to a proper waste collection site, in order to let it be disposed according to 2002/96 / CE (RAEE - WEEE) directives.





“MUSA Plus”

Electronic control for towel radiators

Connection to Fil-Pilote system

(Only for product versions equipped with "Fil-Pilote")

Example

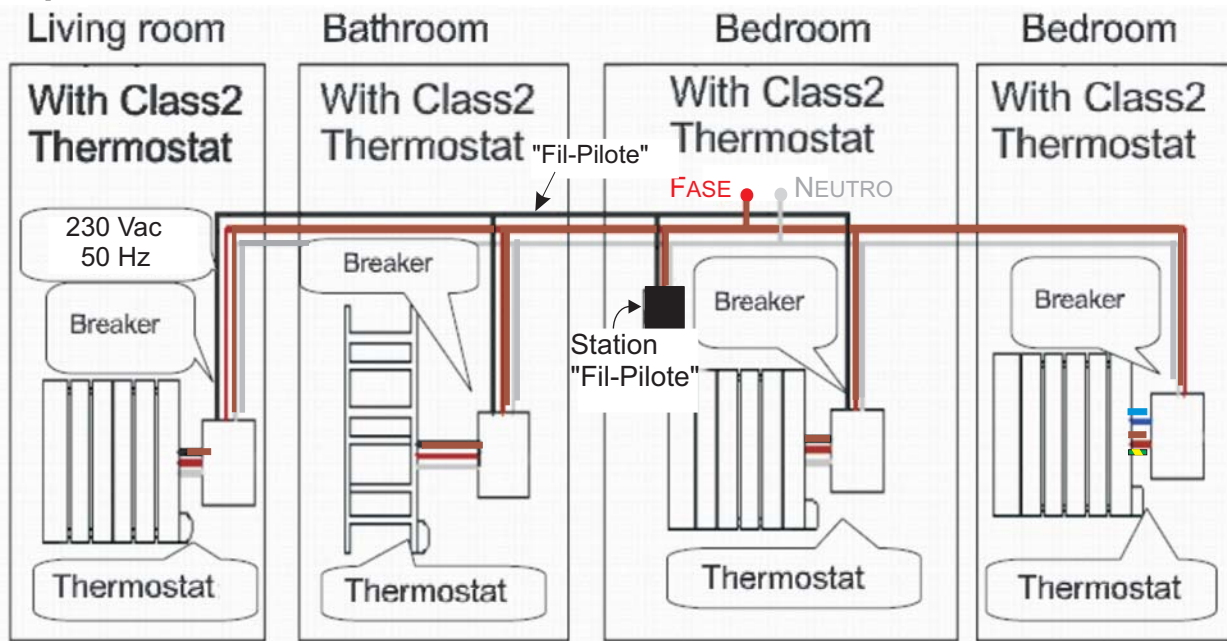

1. A control unit supporting the "Fil-Pilote" system can remotely control a Musa device with "Fil-Pilote" functionality (Class II). The brown wire is the Live wire (L), the gray wire is the Neutral wire (N) and the black wire is used for receiving the Fil-Pilote signal.

⚠ Do not connect the black wire to the ground.

2. A Musa Plus device without "Fil-Pilote" functionality (Class I) cannot be remotely controlled. The brown wire is the Live wire (L), the blue wire is the Neutral wire (N) and the yellow/green wire has to be connected to Earth.



“MUSA Plus”

Electronic control for towel radiators

User Manual

IR receiver:
Allows full remote control of the device through the dedicated remote control.

Plastic cover:
The part connecting to the heating element is kept hidden by this special layout, so that the thermostat fits perfectly to the towel radiator.

[+] Button

Button [Prog]

[On/stand-by] Button

[-] Button

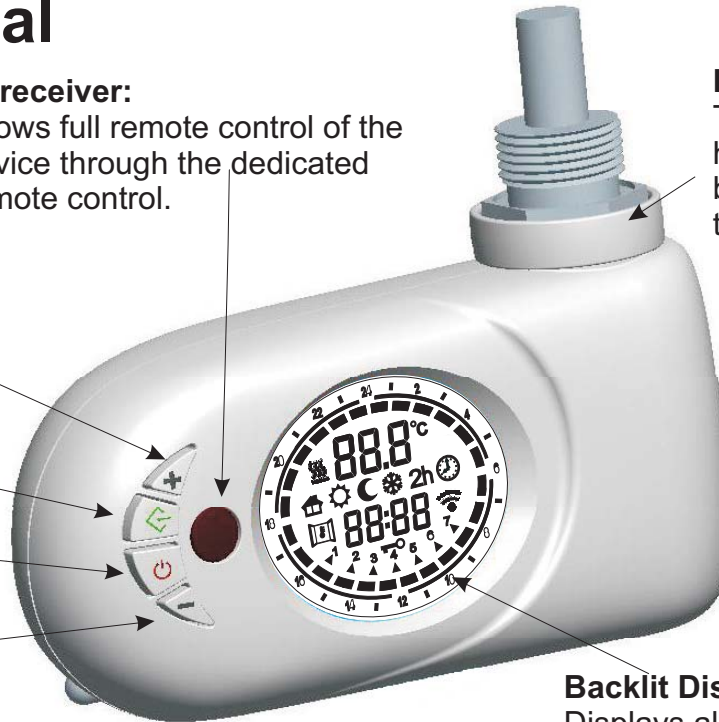

Backlit Display:
Displays all device related information.

Internal buzzer:
For acoustic warnings, compliant with EN60335-1 directive.

Water Protection:
The IP44 protection level is guaranteed by a special design of the connection parts.

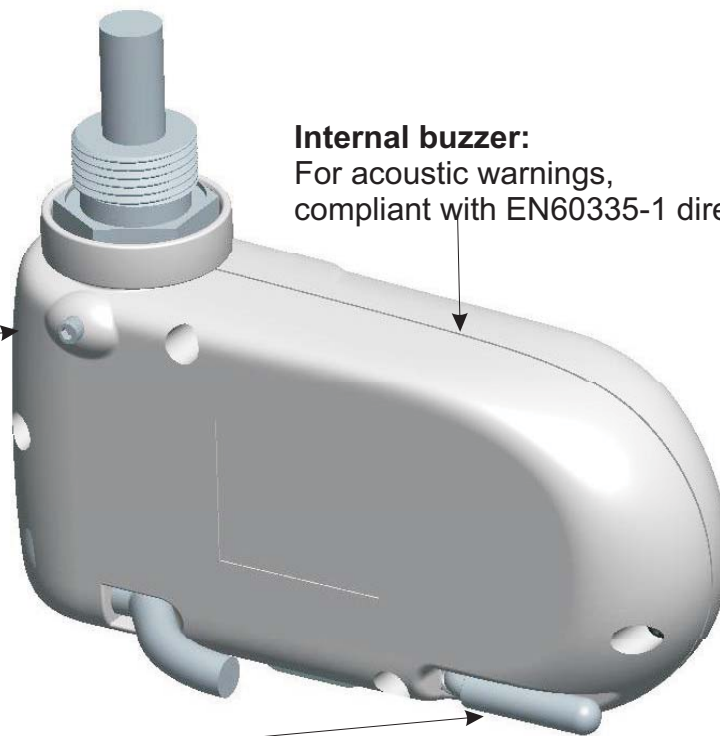

External sensor:
Guarantees a stable room temperature and a prompt reaction in case of strong temperature variation.

Rev. 04 - October 2015



“MUSA Plus”

Electronic control for towel radiators

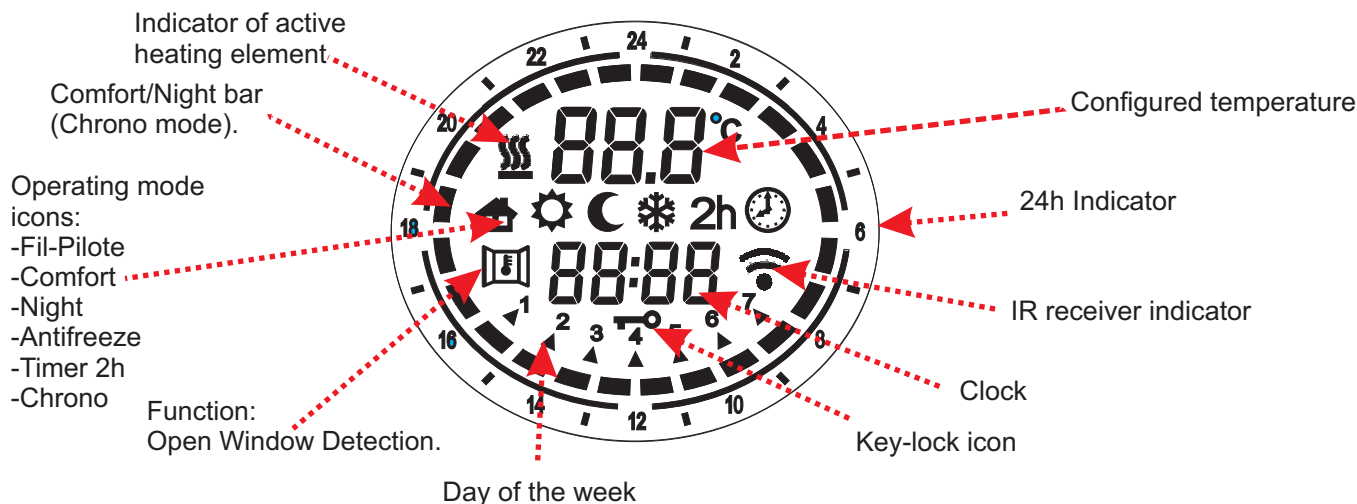

1. POWER ON / STAND-BY

Press the [On/Stand-by] key to turn on the device or to enter the "Stand-by" mode.

When activated, the bottom part of the display shows the current time, while the configured operative mode and the temperature are shown in the upper part. When in "Stand-by" mode current time, day of the week and the message: "Stb" are displayed.

NOTE: When the device goes into "Stand-by" mode it beeps twice for 0.5s.

When the device is activated it beeps once for 1s.

Example in "Comfort" mode.



Example in "Stand-by" mode.



1. "COMFORT" and "NIGHT" MODES

Two different levels of temperature can be set:

- "COMFORT" temperature: It is the temperature used for "Chrono", "Fil-Pilote" and "Comfort" modes.

- "NIGHT" temperature: It is the temperature used for the "Night" and "Chrono" modes.

The desired temperature can be set pressing the [+] e [-] buttons. The range of configurable temperature is 7°C - 32°C.

IMPORTANT!

The temperature of "Night" mode must be below to the "Comfort" mode temperature. For this reason the "Night" mode temperature can be set to a value between 7°C and the (configured "Comfort" mode temperature - 0.5°C).

The temperature of "Comfort" mode can be configured in the whole (Night temperature + 0.5°C) ÷ 32°C range.





“MUSA Plus”

Electronic control for towel radiators

1. OPERATING THE DEVICE

Press the **[PROG]** button to select the desired operative mode. An icon on the display indicates the selected operating mode, according to the following table:

				2h	
Fil-Pilote	Confort	Night	Antifreeze	Timer 2H	Chrono

COMFORT MODE

The "Comfort" stably maintains the room temperature to a selected value. To set this operative mode:

- Press the **[Prog]** button until the display shows the "Comfort" icon
- Set the desired temperature through **[+]** and **[-]** buttons and wait until the displayed temperature stops blinking.

NIGHT MODE

The "Night" mode sets a value of temperature below the "Comfort" temperature value.

It is suggested to set this operating mode during the night or when the room is not occupied for 2 or more hours.

- Press the **[Prog]** button until the display shows the "Night" icon
- Set the desired temperature through **[+]** and **[-]** buttons and wait until the displayed temperature stops blinking.

ANTIFREEZE MODE

In "Antifreeze" mode the temperature is fixed to 7°C. The device activates the heating element when the room temperature falls below 7°C. It is suggested to set this operating mode when the room is not occupied for several days. Press the **[Prog]** button until the display shows the "Antifreeze" icon

TIMER-2H MODE

The "Timer 2h" mode can be used to quickly warm up the room or to speed up towel drying.

- Press the **[Prog]** button until the display shows the "2h" icon.
- The device is activated at the maximum power for 2 hours, up to a maximum room temperature of 32°C. The "Timer-2h" mode is automatically deactivated after a period of 2 hours and the device returns to the operative mode previously set. The user can switch to another operative mode at any time by simply pressing the **[PROG]** button.

FIL-PILOTE MODE (Only for product versions equipped with "Fil-Pilote")

In "Fil-Pilote" mode the device is managed by a central control system that sets the operating mode for all the connected devices. The device operates with the most advanced "Fil-Pilote" system with six commands, which allows the following functions:

1. Standby: power off the heating element, the device remains active.
2. Comfort: maintains the "Comfort" temperature set by the user.
3. Eco: maintains the room temperature 3,5°C below the "Comfort" temperature.
4. Anti-freeze: maintains the room temperature at 7°C.
5. Eco-1: maintains the room temperature 1°C below the "Comfort" temperature.
6. Eco-2: maintains the room temperature 2°C below the "Comfort" temperature.

The user can set the desired temperature on the device:

- Press the **[Prog]** button until the "Fil-Pilote" icon is displayed.
- Set the desired temperature through the **[+]** and **[-]** buttons and wait until the displayed temperature stops blinking.

Rev. 04 - October 2015



“MUSA Plus”

Electronic control for towel radiators

CHRONO MODE

This operating mode allows the user to configure different temperature values for each hour of each day of the week. The “Comfort” / “Night” temperatures and the related time intervals can be thus programmed.

-To activate this function, press the **[PROG]** button until the “Chrono” icon is displayed.

Programming the “Chrono” mode

a) Setting the current day of the week and time

- Enter into “Stand-by” mode and press the **[-]** button at least 3 seconds.
- On the upper part of the display the message “Set” will be displayed
- To set the day and time press the **[+]** button until the bottom part of the display the message “TED” is displayed (see picture on the right).
- Press the **[Prog]** button to enter the editing mode
- The blinking arrow indicates the currently selected day: Pressing the **[+]** / **[-]** buttons the desired day can then be set
- Press again the **[Prog]** button to confirm the selected day.

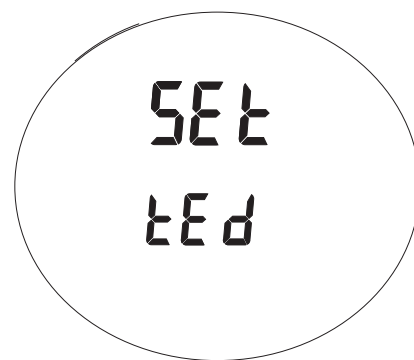

After that, the procedure for entering the time starts and the display shows the currently selected time. “Hours”: Use the **[+]** and **[-]** buttons to set the correct hour and confirm the selected value pressing the **[Prog]** button.

Minutes: Same procedure as for the hours. Confirm the selected value by pressing the **[Prog]** button.

- At the end of the procedure, the thermostat returns into “Stand-by” mode.

b) Setting the program for the “Chrono” mode

- Enter into “Stand-by” mode and press the **[-]** button at least 3 seconds.
- On the upper part of the display the message “Set” will be displayed
- To set the day and time press the **[+]** button until the bottom part of the display the message “Prog” is displayed (see picture on the right).
- Press the **[Prog]** button to enter the editing mode
- Now a time sequence can be defined for each day of the week.

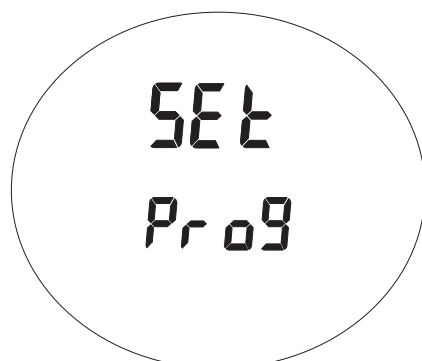

The procedure starts with day 1, and the desired sequence can be configured with the **[+]** and **[-]** buttons: For each hour of the day, it is then possible to assign either the “Comfort” temperature (full bar indication displayed) by pressing the **[+]** button or the “Night” temperature (empty bar) by pressing the **[-]** button (see picture below). Press **[PROG]** to confirm the entered configuration for day 1, and repeat the same procedure for the remaining 6 days of the week.

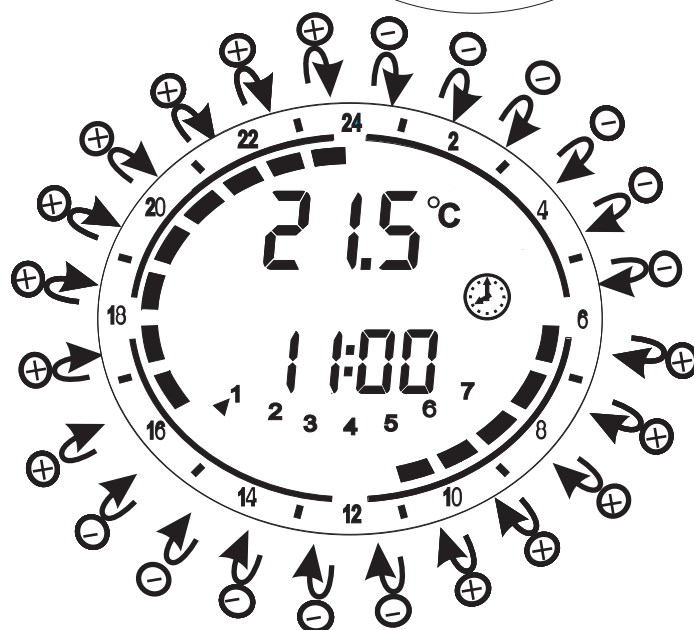

Rev. 04 - October 2015



“MUSA Plus”

Electronic control for towel radiators

4. KEY LOCK

It is possible to lock the buttons of the device to avoid inadvertent modifications of the settings.

Press together the [PROG] buttons for 3 seconds to lock all the buttons except the [On/Stand-by] button. The key-lock icon is activated on the display.

To unlock the buttons press again together the [PROG] buttons for 3 seconds. The key-lock icon disappears on the display

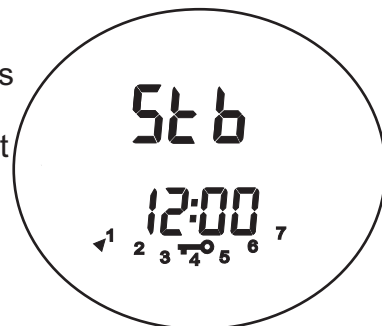

5. “Open Window Detection” function

The “Open Window Detection” function enables detecting of an open window by sensing a sudden decrease of the temperature in the room. In such a case, the device deactivates the heating element for a maximum of 30 minutes or until an increase of the room temperature reveals that the window has been closed.

To activate this function:

- Enter into “Stand-by” mode.
- Press the [+] button for 3 seconds.
- Press the [+] button to activate / deactivate the function
- Press the [Prog] button to commit and return into “Stand-by” mode.

When this function is enabled, the “Open Window” icon on the display is lit.

When the device detects that the window is potentially opened, the “Open Window” icon starts blinking

When the function is disabled the “Open Window” icon is not shown on the display.

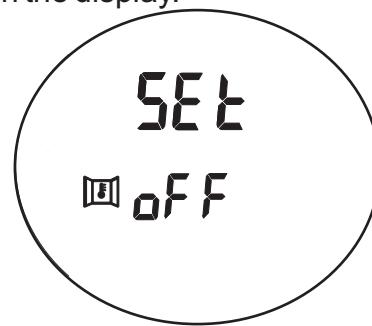
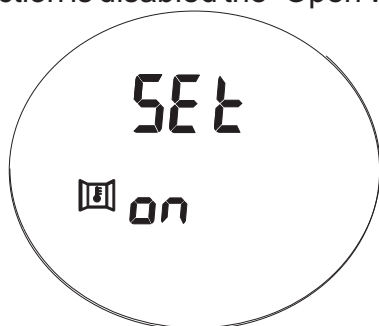

Note: The device could fail in detecting an opened window e.g. if the thermostat is located on an isolated area of the room and far from air currents or if the thermostat is placed close to an external heating source, or if the temperature variation in the room is too slow.

Note 1: When the symbol "SSS" is on, the heating element is active.

Note 2: This icon "📶" indicates that it is being received signal from the remote control.

Note 3: In case of loss of power supply, the settings of the “Chrono” mode (current day of the week, current time, daily program for the week) remain stored in memory for a few minutes.

REMOTE CONTROL (OPTIONAL)

Musa is equipped with an IR receiver and therefore it can be remotely controlled through the optional remote control device. All the functions previously described are available on the remote control.

The manufacturer reserves the right to make any changes to the product described in this manual, at any time, and without prior warning.

Rev. 04 - October 2015